



LET THE LIGHT FLOOD IN

ORANGERIES AND EXTENSIONS

Ultrasky[®]
ALUMINIUM by Ultraframe

A man and a woman are sitting on a light-colored sofa in a modern living room. The man is wearing a black t-shirt and glasses, and the woman is wearing a black top and pants. They are both looking towards the right. The room features a large skylight with a dark frame, a stone wall, and a dark wood kitchen area with a built-in oven. The overall atmosphere is bright and contemporary.

Ultrasky Aluminium creates the perfect living space whether you're entertaining, relaxing with your family, or having a cosy night in.

Ultrasky Aluminium combines fresh modern styling with natural light to create a beautiful warm glazed extension with the style and grandeur of a traditional orangery. Engineered by Ultraframe, strength is the secret behind Ultrasky's success. A stronger, thermally insulated ridge means less bars are needed drawing more light into the room.



ULTRASKY, IT'S
NOT JUST HOW
IT LOOKS AND
FEELS,

IT'S HOW IT WORKS!

ULTRASKY ALUMINIUM, **4 OPTIONS** TO CREATE THE ULTIMATE ORANGERY OR EXTENSION

Ultrasky's revolutionary roofing systems put warmth and light at the heart of your new extension or orangery design.

Guaranteed for 10 years, the market's strongest glazed roofs are designed to flood your new room with light.

Choose from four simple, stylish aluminium roofing systems to create the ultimate orangery or extension.

Ultrasky[®]

ORANGERY by Ultraframe

Designed for spectacular builds up to 8m x 5.6m, the Ultrasky Orangery is the ultimate in architectural aluminium design with elegant uninterrupted sightlines. Ultrasky Orangery uses an integrated goalpost to support large spans of bi-folding or sliding doors up to 6m. Add aluminium super-insulated columns and a flat cornice for an elegant and stylish finish.

See pages 6 -9 for more details.



Ultrasky[®]

ROOF by Ultraframe

The aluminium Ultrasky Roof maximises light by extending to the eaves beam rather than using a flat roof. This slimline roof with no bulky radius ends and less bars lets in more light than a traditional orangery or flat roof extension. A choice of aluminium external cornices add shape and style to the roofline, hide unsightly gutters and the variable width pelmet adds insulation to ensure your orangery or extension is always warm and cosy.

See pages 10-11 for more details.



Ultrasky[®]

LANTERN by Ultraframe

The aluminium Ultrasky Lantern can be inserted into a flat roof or a traditional orangery deck and is ideal for large builds where the roof height is restricted. Ultrasky Lantern has a 25° pitch which draws more light into the room creating a stunning focal point. Using the strongest ridge on the market, Ultrasky has significantly less bars than other lanterns.

See pages 12 -15 for more details.

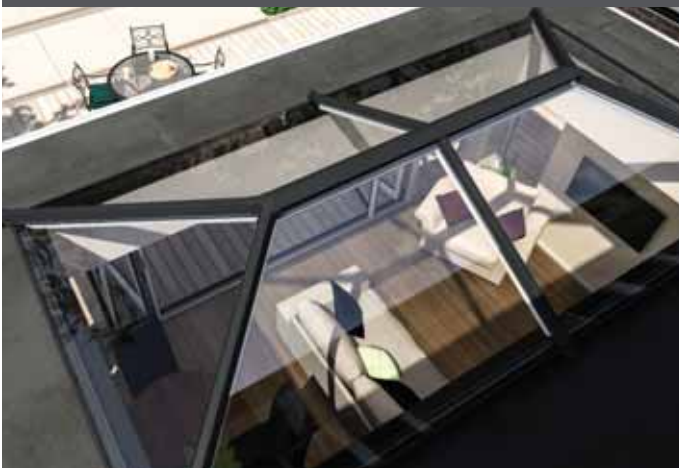

Ultrasky[®]

SKYLIGHT by Ultraframe

Installing an Ultrasky Flat Skylight will flood your room with natural light. A thermally insulated core and optional insulated kerb provide unrivalled thermal performance. Frameless edge to edge glass with an aluminium surround provides the ultimate in simple contemporary design.

See pages 16-17 for more details.

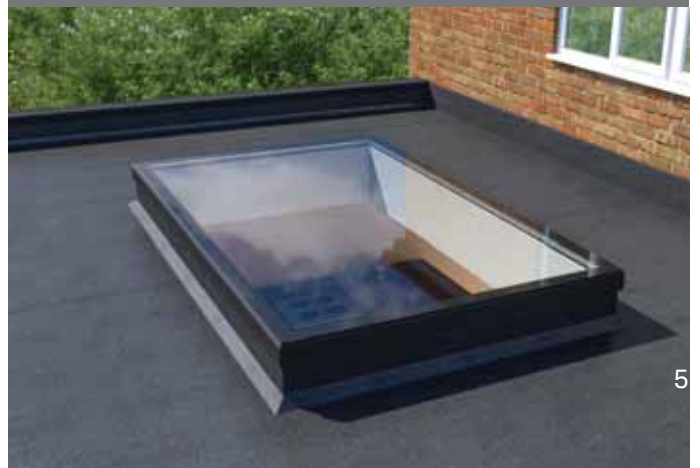



With Ultrasky Orangery you have the whole package; Ultrasky Roof, super-insulated columns, insulated pelmet and cornice. For a contemporary look, the flat cornice available in 1, 2, or 3 tier looks amazing with aluminium bi-fold or sliding doors.

Inside, the variable width pelmet insulates the eaves and creates a perimeter ceiling with a room-like feel. Add spotlights or speakers to inspire and impress.



ULTRASKY **ORANGERY,** SIMPLE, STYLISH & ELEGANT



Match an aluminium super-insulated column to your cornice in a bespoke colour to create something really unique.



ULTRASKY ALUMINIUM, LET THE OUTSIDE IN TO YOUR **ORANGERY OR EXTENSION**

At the heart of Ultrasky Orangerie are the ingenious aluminium super-insulated columns. Bringing strength and solidity to your design, they are constructed around a thermally insulated core, and are five times more thermally efficient than a similar sized brick pillar. The integrated structural frame means you can design in larger expanses of glass and aluminium bi-fold or sliding doors, than you would with a traditional brick built orangerie.



Depending on the look you choose, super-insulated columns can be wide or narrow with a plain or fluted aluminium finish and are available in any colour to complement or contrast with your property.

LET
ULTRASKY
TAKE THE
WEIGHT
OFF



Ultrasky Roof is perfect for spanning aluminium bi-folding or sliding doors. A super-strong, slim line structural frame with unique Ultraspan technology works together with the roof beam to reduce the deflection pressure on your doors.

Every Ultraspan frame is easily integrated with brick pillars, super-insulated columns or a simple post. Our team of engineers take care of the structural calculations to design and manufacture a bespoke frame for your new extension or orangery.



The unique Ultraspain frame is concealed within the Ultrasky Roof for uninterrupted sight lines and maximum light.



LIGHTER
AND BRIGHTER

ORANGERY AND EXTENSIONS

Ultrasky Lantern's extra strength means less bars and uninterrupted sight lines for maximum light. It is available in a wide variety of sizes to a maximum width of 4m and a length of 5.85m.



ULTRASKY LANTERN, **MAXIMISE** NATURAL LIGHT IN YOUR ORANGERY OR EXTENSION

Sitting on a flat roof or traditional orangery deck, the aluminium Ultrasky Lantern draws maximum light into your orangery or extension. The elegant 25° pitch to all four sides provides a stunning addition to any room - ideal for creating a focal point in a dining room or kitchen.





ULTRASKY FLAT SKYLIGHT,
SIMPLE, STYLISH, ALUMINIUM



The Ultrasky Aluminium Flat Skylight provides an element of style to extension and orangery roofs by flooding natural light into previously dark gloomy rooms. Its distinctive sleek, frameless edge-to-edge design plus blue glass option gives a stunning contemporary look that complements the style of the roof and allows the largest possible amount of light into the room. The Ultrasky Flat Skylight is frameless from the inside, giving a bright open feel. The fully insulated frame with 'Warm Frame' technology and high performance noise reducing glass means the flat skylight blocks out noise from the outside and is unrivalled in thermal efficiency.

*Noise reducing glass on 26mm only

The design options with Ultrasky are endless. Ultrasky Roof, Lantern and Skylight are available in grey or white as standard or choose a bespoke colour to suit your property.

For Ultrasky Roof an extensive range of aluminium decorative cornices add style and shape to the roofline, concealing gutters and rafter ends. There are 4 styles to choose from.

Design the width of your internal pelmet to suit your new room from 300mm to 1200mm. The added insulation in the pelmet will ensure your new orangery or extension is always warm, welcoming and cosy.

UNRIVALLED CHOICE OF STYLES FROM ULTRASKY

STANDARD COLOURS

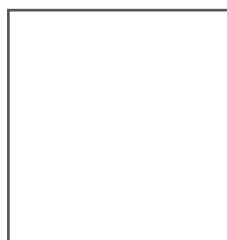

White



Anthracite Grey



Black

Bespoke colours available to order on Ultrasky Roof, Lantern and Flat Skylight.



1. Ultrasky Flat Skylight in black, available with kerb. 2. Traditional orangery with a curved grey cornice.
3. Ultrasky Lantern with a grey external finish. 4. Ultrasky Orangery in agate grey with a 3 tier flat cornice.
5. Ultrasky Lantern with an anthracite grey aluminium internal finish. 6. 4 styles of cornice to choose from.



ULTRASKY ROOF

FEATURES

- 1 High performance thermal break
- 2 Patented thermally insulated aluminium rafter
- 3 Super strong ridge for fewer bars and more light
- 4 Thermally isolating top cap clip
- 5 'Secure-fit' end caps for a further thermal barrier
- 6 Patented insulated perimeter ceiling (max. 1200mm wide)
- 7 Housing for additional insulation, speakers or down lights
- 8 Decorative Cornice to hide gutters and add shape to the roofline
- 9 'Heat guard' modesty shield
- 10 Adjustable reinforced stopper to prevent glass slipping



STRENGTH, WARMTH
AND MAXIMUM LIGHT

PERFORMANCE ENGINEERING

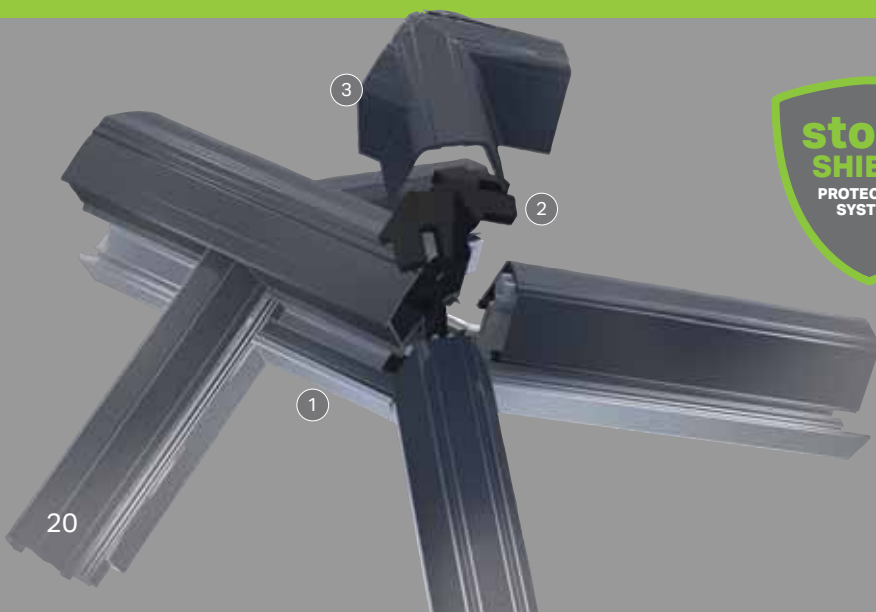

ULTRASKY'S STORMSHIELD PROTECTION SYSTEM INCLUDES:

- 1 Waterproof glazing compression trims
- 2 Ridge end weathering shields
- 3 'Secure fit' radius end covers

ULTRASKY LANTERN



FEATURES

- 1 High performance thermal break
- 2 Patented thermally insulated aluminium rafter
- 3 Super strong ridge for fewer bars and more light
- 4 Thermally isolating top cap clip
- 5 'Secure-fit' end caps are a further thermal barrier
- 6 Thermally broken eaves rail
- 7 Superior 25° pitch for elegance and light
- 8 Adjustable reinforced stopper to prevent glass slipping

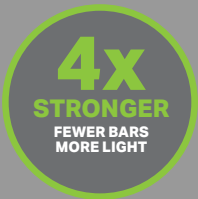
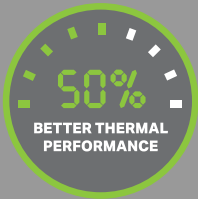

ULTRASKY FLAT ROOF LIGHT



FEATURES

- 1 Edge to Edge glass for a contemporary look
- 2 Finline plasterboard trim for a neat internal finish
- 3 Slim aluminium surround blends seamlessly with glass
- 4 Fully insulated frame with Warm Frame technology
- 5 Click-fit clips for quick fitting first time, every time
- 6 Noise reducing glass reduces noise by up to 34dB.
- 7 Double seal gaskets with high compression, so seal won't degrade over time.

ULTRASpan Structural Goal Post

FEATURES

- 1 Aluminium vertical post
- 2 Aluminium horizontal beam
- 3 Protective adhesive expanding foam tape
- 4 Aluminium L-shaped header bracket
- 5 Extra external fascia trim
- 6 Modesty panel factory cut to fit
- 7 Internal fascia factory cut to fit
- 8 Protective adhesive glazing packer



PROVEN AND VALID
STRUCTURAL INTEGRITY

PERFORMANCE ENGINEERING

Ultraspan is completely hidden inside the Ultrasky Roof, can accommodate unsupported spans up to 6.5m and is available in a variety of finishes to seamlessly match your design.

Super-Insulated COLUMNS

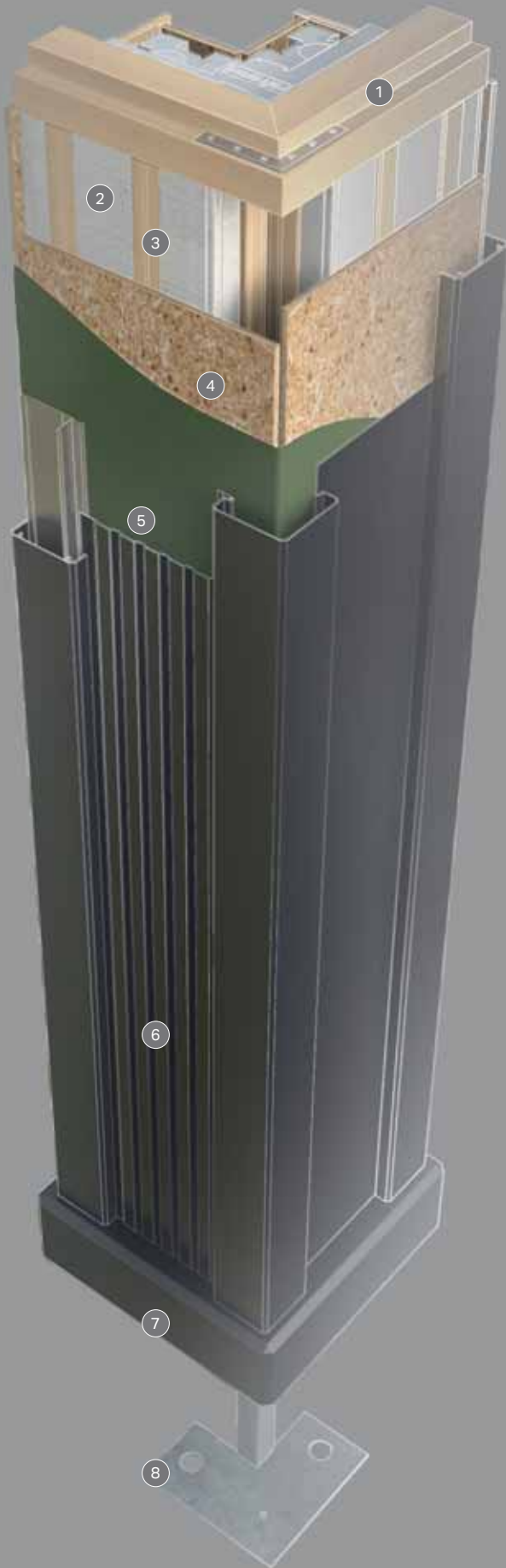

FEATURES

- 1 Eaves beam supporting platform
- 2 Styropor carbon enriched expanded polystyrene insulated core
- 3 Anchoring battens
- 4 OSB board, mechanically fixed to battens
- 5 Beatheable membrane
- 6 Powder coated aluminium claddings
- 7 Various base details available
- 8 Structural set out post

ADD THERMAL **EFFICIENCY** AND STYLE

The perfect complement to Ultrasky Roof and five times more thermally efficient than a brick pillar, super-insulated columns allow you to add more glazing into the design while maintaining thermal efficiency.

Plastered on the inside, super-insulated columns are a great way to eliminate brickwork and mess during installation and provide the solidity of a brick pillar.

A super-insulated column with the right glazing options can surpass the thermal performance requirements of a brick built extension.



Ultraframe[®]
Transforming light and space

Job No. 3991 LAN009 Ultrasky 12/18

It is Ultraframe's policy to continually seek to improve its products, processes and service and we reserve the right to change specifications without prior notice. We have been trading for nearly 35 years and strive to deliver unrivalled quality and service.